

Model 34 TP 3.0X3.0

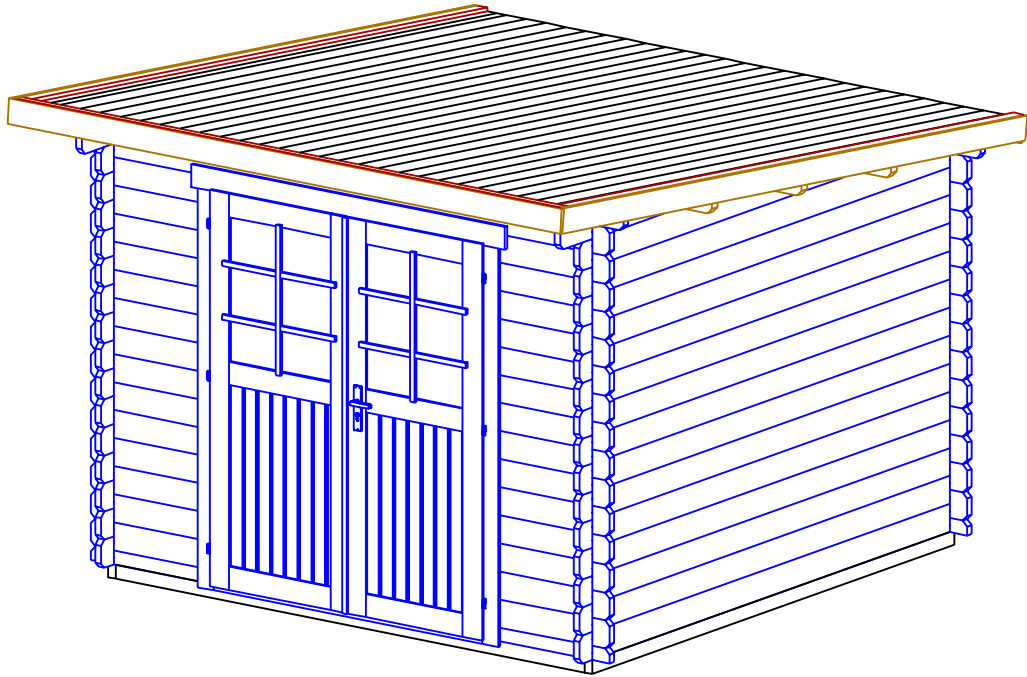

Mara 34 TP 3.0X3.0

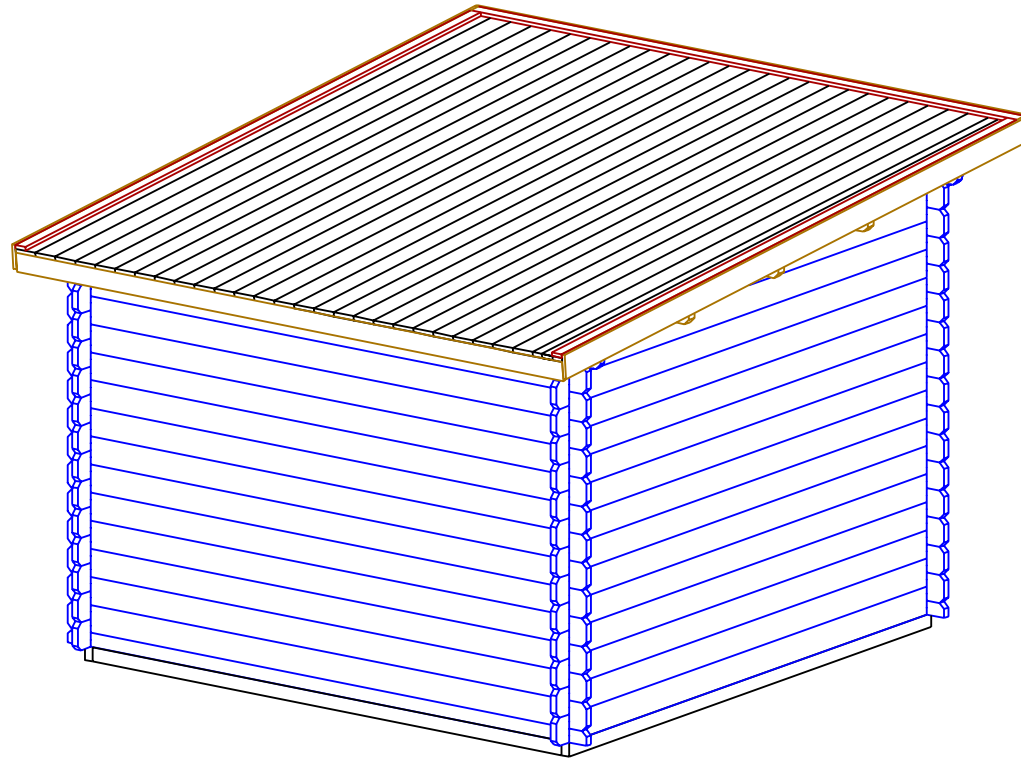

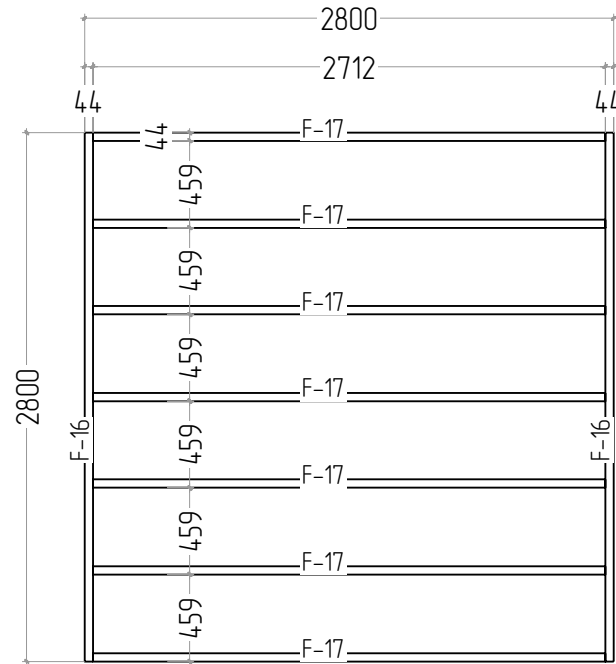

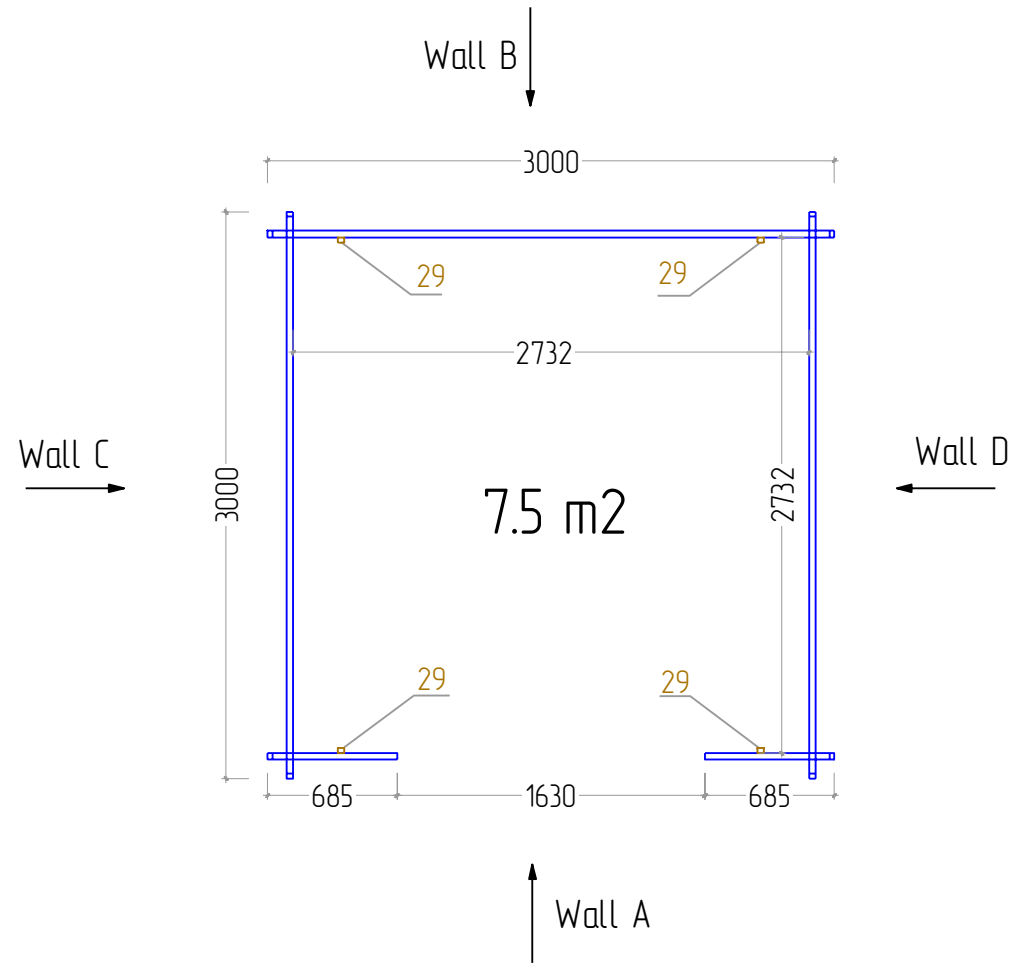

STAGE 2

Mara 34 TP 3.0X3.0

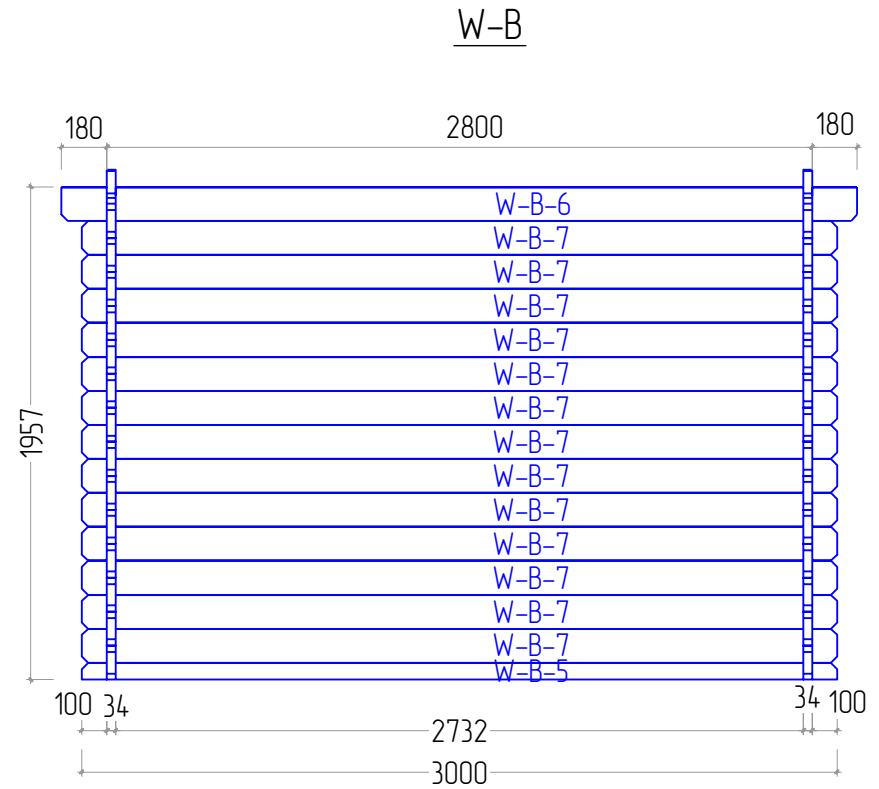
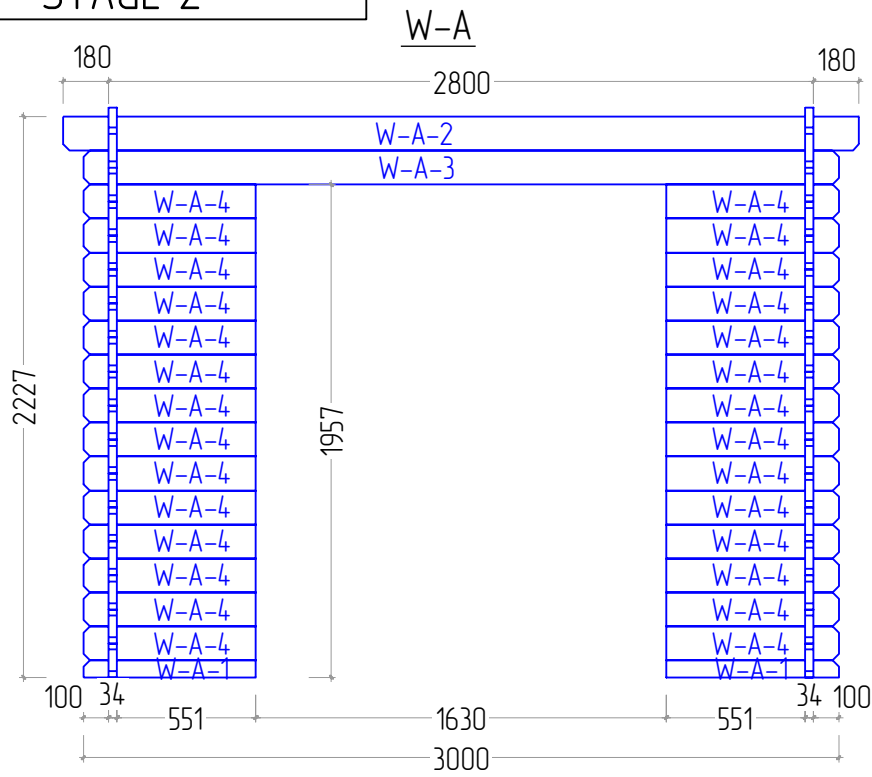

STAGE 3

Marra 34 TP 3.0X3.0

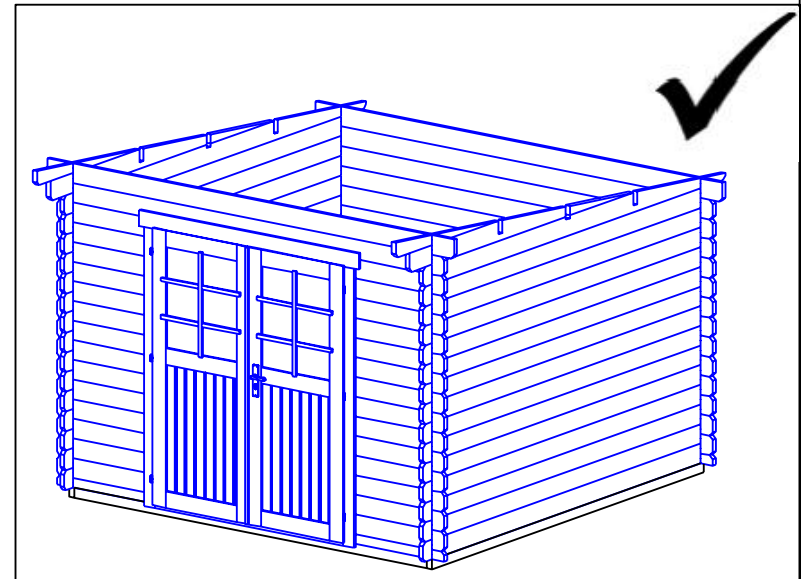
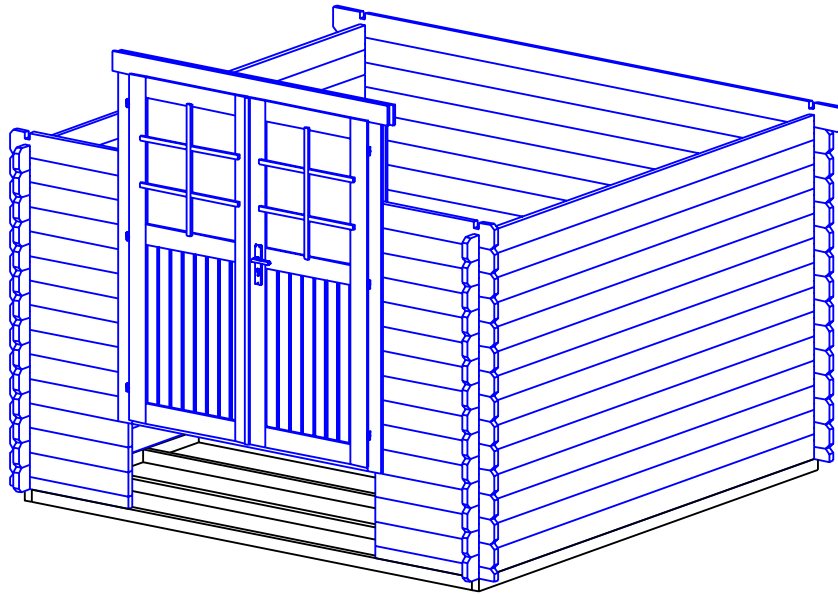

STAGE 4

Mara 34 TP 3.0X3.0

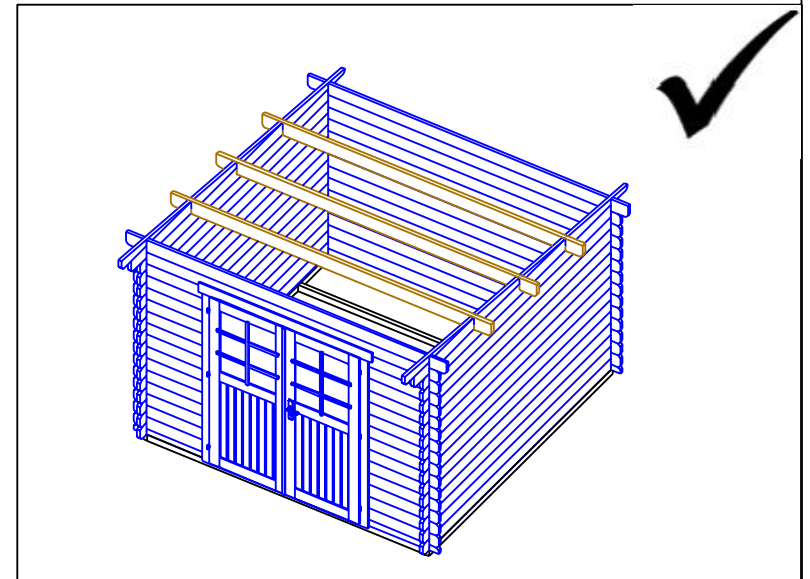
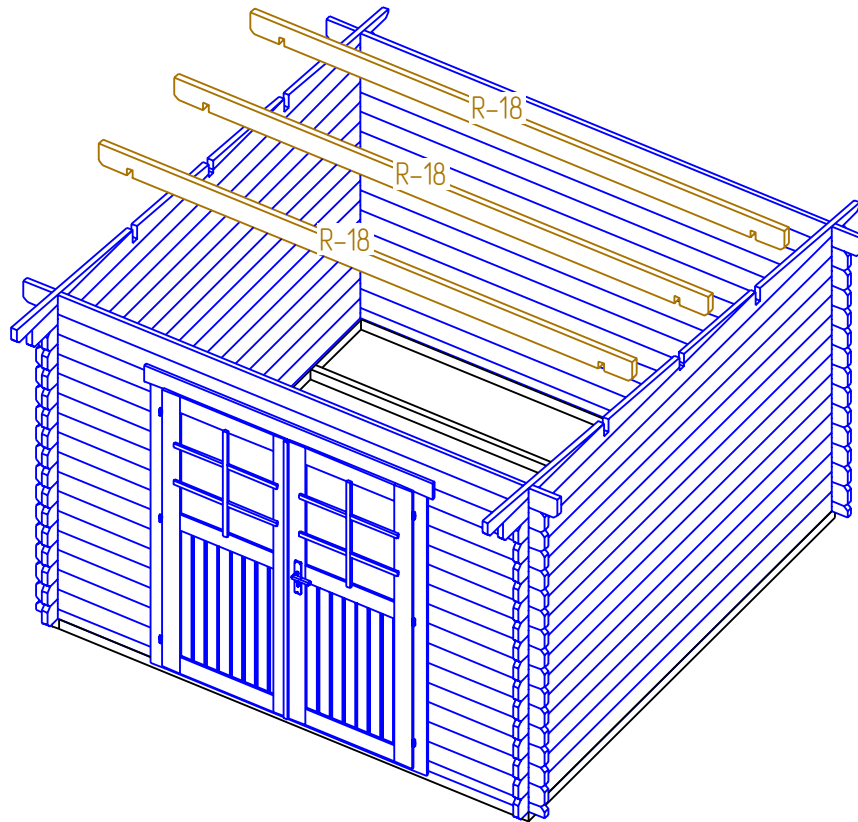

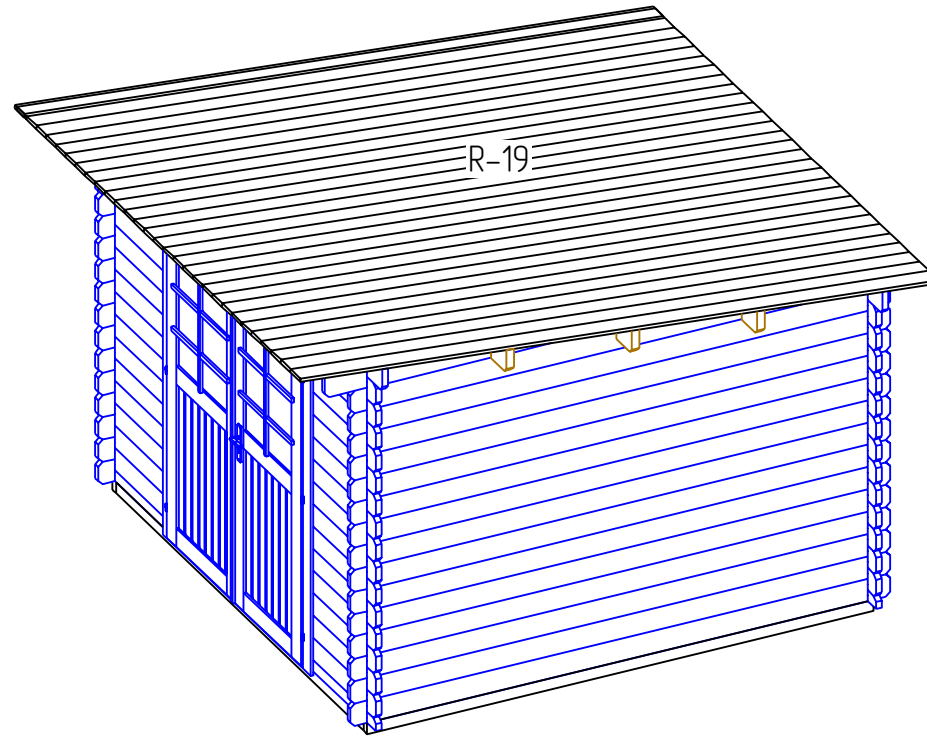

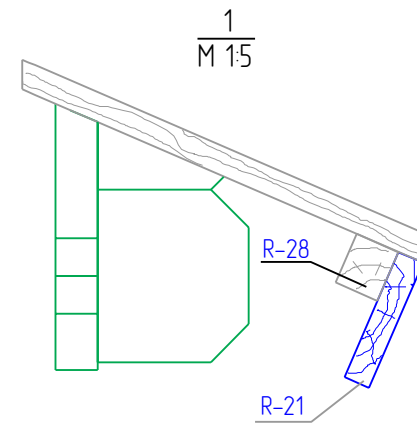
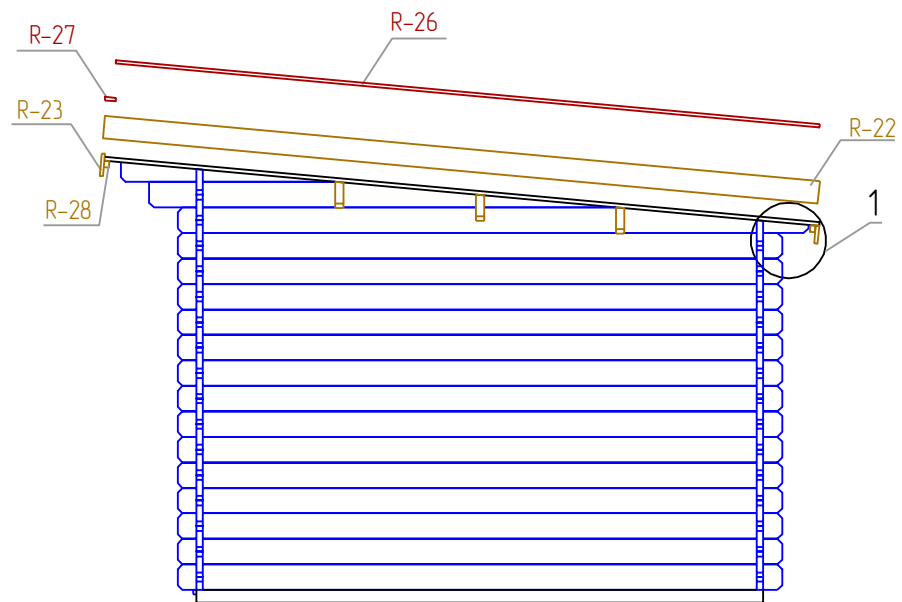

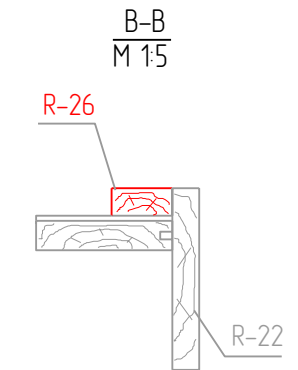
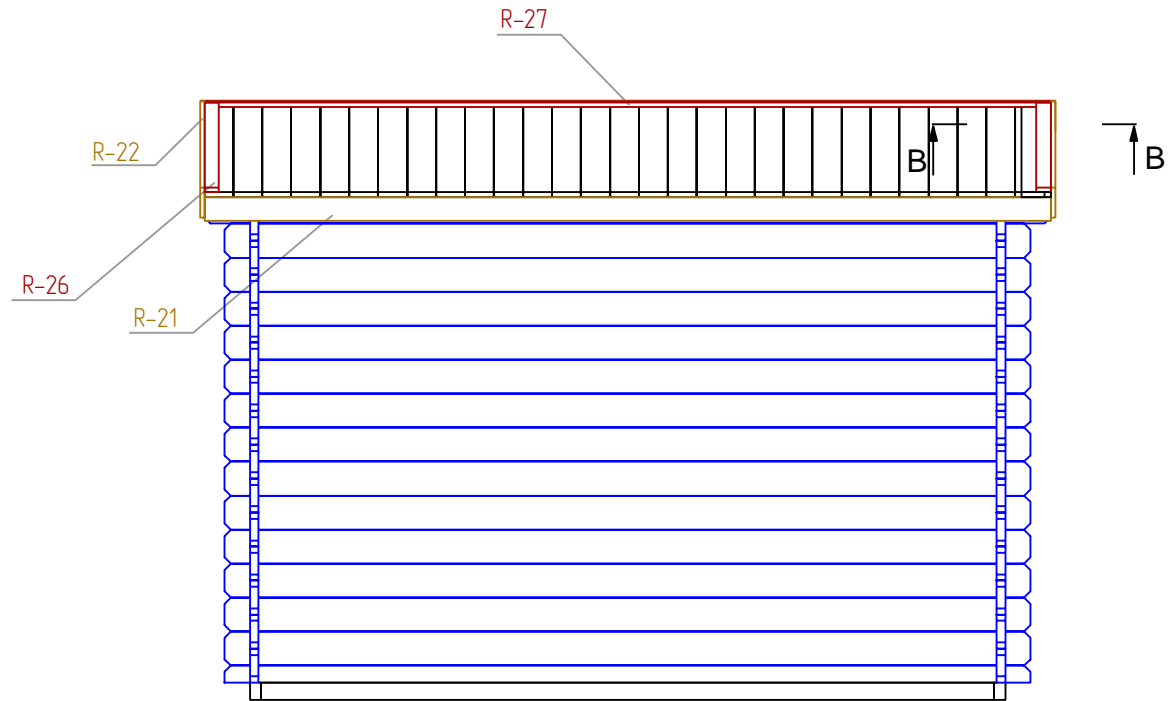

STAGE 7

Mara 34 TP 3.0X3.0

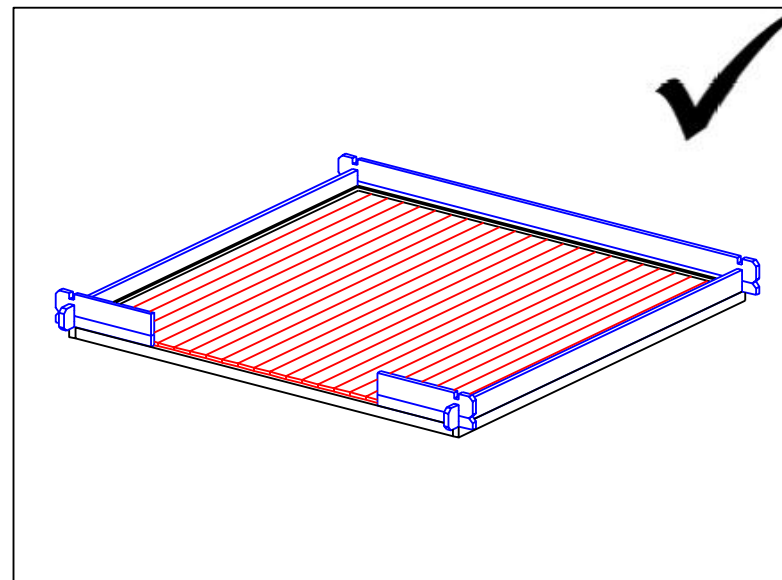
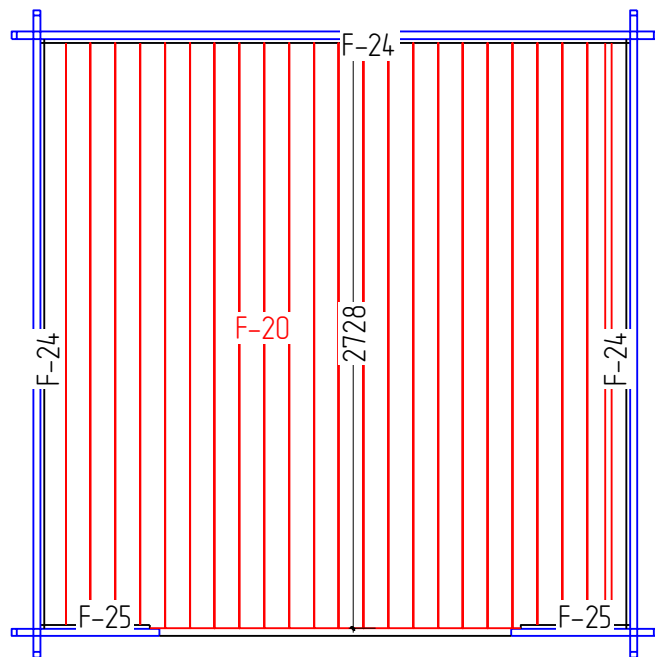

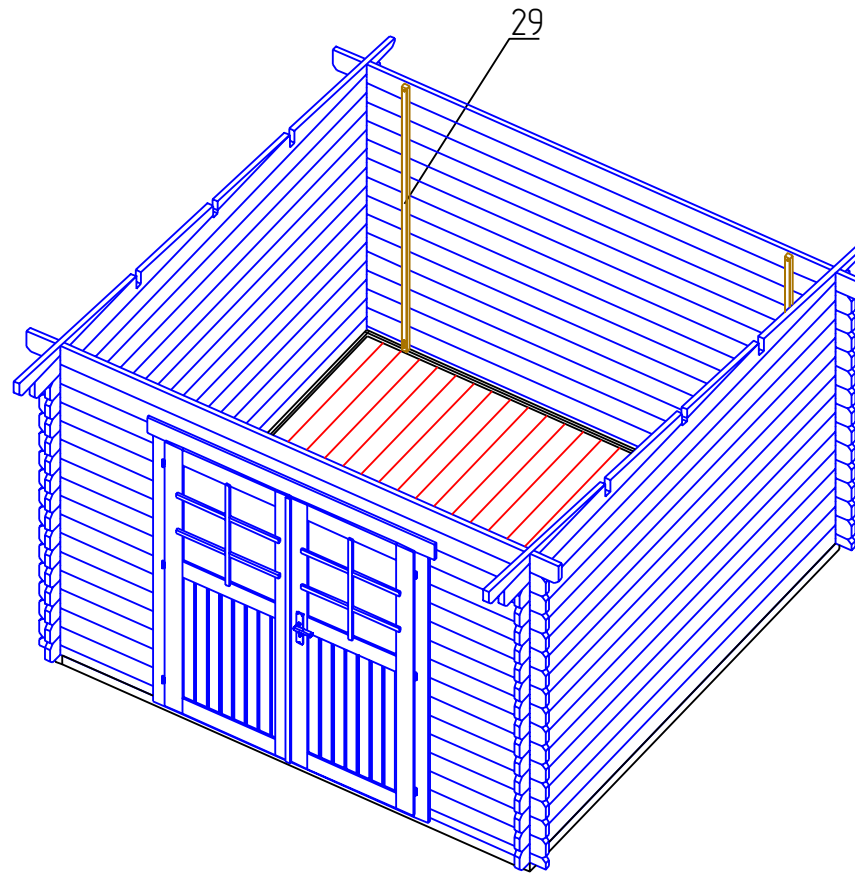

STAGE 1

F
NR: 16
PSC: 2
B/H: 44mm/68mm
L: 2800mm



F
NR: 17
PSC: 7
B/H: 44mm/68mm
L: 2712mm

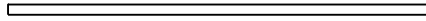

STAGE 2

W
NR: A 1
PSC: 2
B/H: 34mm/68mm
L: 685mm

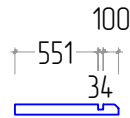

W
NR: A 2
PSC: 1
B/H: 34mm/135mm
L: 3160mm

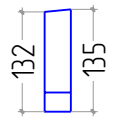
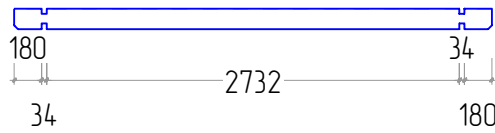

W
NR: A 3
PSC: 1
B/H: 34mm/135mm
L: 3000mm

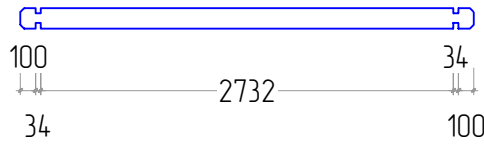

W
NR: A 4
PSC: 28
B/H: 34mm/135mm
L: 685mm

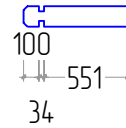

W
NR: B 5
PSC: 1
B/H: 34mm/68mm
L: 3000mm

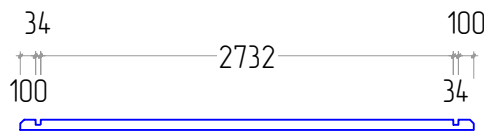

W
NR: B 6
PSC: 1
B/H: 34mm/135mm
L: 3160mm

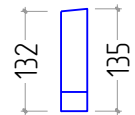
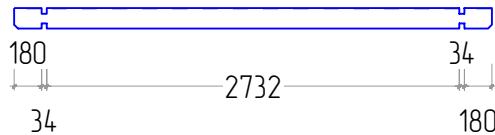



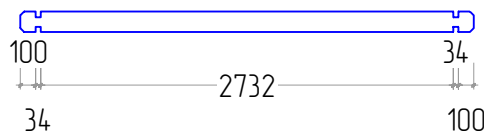

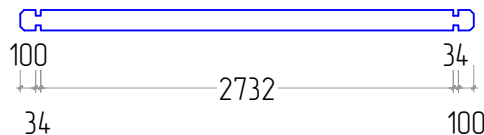

W
NR: B 7
PSC: 14
B/H: 34mm/135mm
L: 3000mm



W
NR: C 10
PSC: 14
B/H: 34mm/135mm
L: 3000mm



<p>W NR: D 14 PSC: 14 B/H: 34mm/135mm L: 3000mm</p>	
<p>W NR: D PSC: 1</p>	
<p>W NR: C PSC: 1</p>	
<p>STAGE 3</p>	
<p>Door PSC: 1 B/H: 1630mm/1958mm</p>	
<p>STAGE 4</p>	
<p>R NR: 18 PSC: 3 B/H: 44mm/140mm L: 3160mm</p>	
<p>STAGE 5</p>	
<p>R NR: 19 PSC: 29 B/H: 20mm/115mm L: 3600mm</p>	
<p>STAGE 6</p>	
<p>R NR: 21 PSC: 1 B/H: 18mm/95mm L: 3160mm</p>	
<p>R NR: 22 PSC: 2 B/H: 18mm/120mm L: 3600mm</p>	
<p>R NR: 23 PSC: 1 B/H: 18mm/120mm L: 3196mm</p>	

R NR: 26 PSC: 2 B/H: 18mm/58mm L: 3542mm	
R NR: 27 PSC: 1 B/H: 18mm/58mm L: 3160mm	
R NR: 28 PSC: 2 B/H: 28mm/34mm L: 3160mm	
STAGE 7	
F NR: 20 PSC: 25 B/H: 20mm/115mm L: 2728mm	
F NR: 25 PSC: 2 B/H: 18mm/20mm L: 508mm	
F NR: 24 PSC: 3 B/H: 18mm/20mm L: 2732mm	
STAGE 8	
NR: 29 PSC: 4 B/H: 28mm/34mm L: 1900mm	

W-D

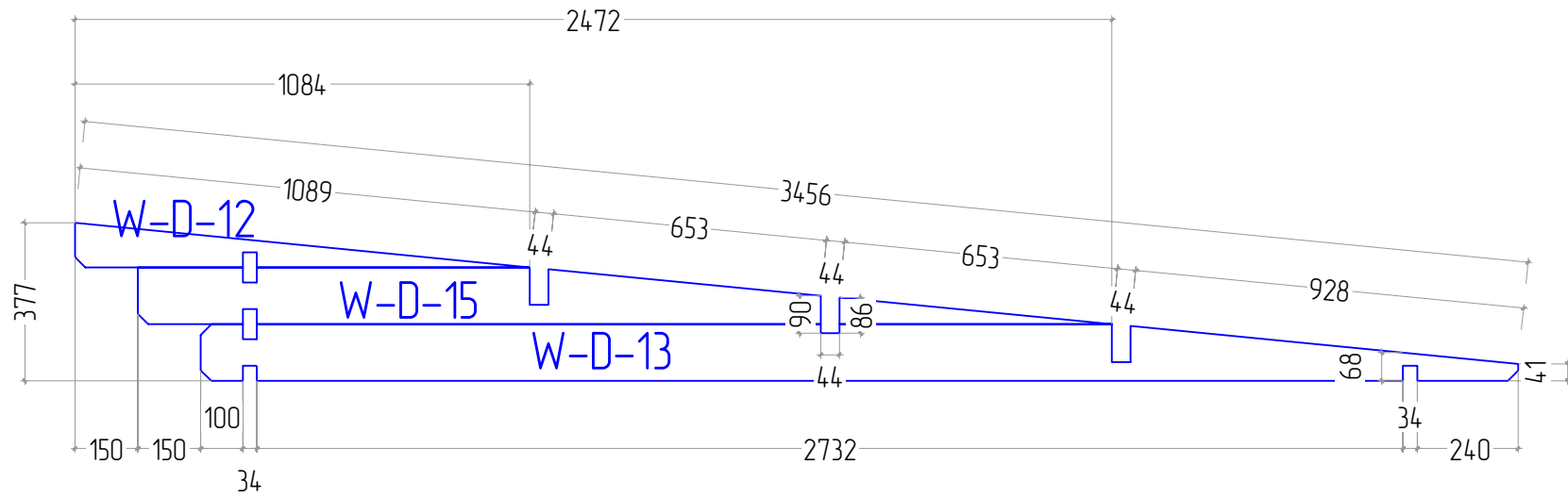

W-С

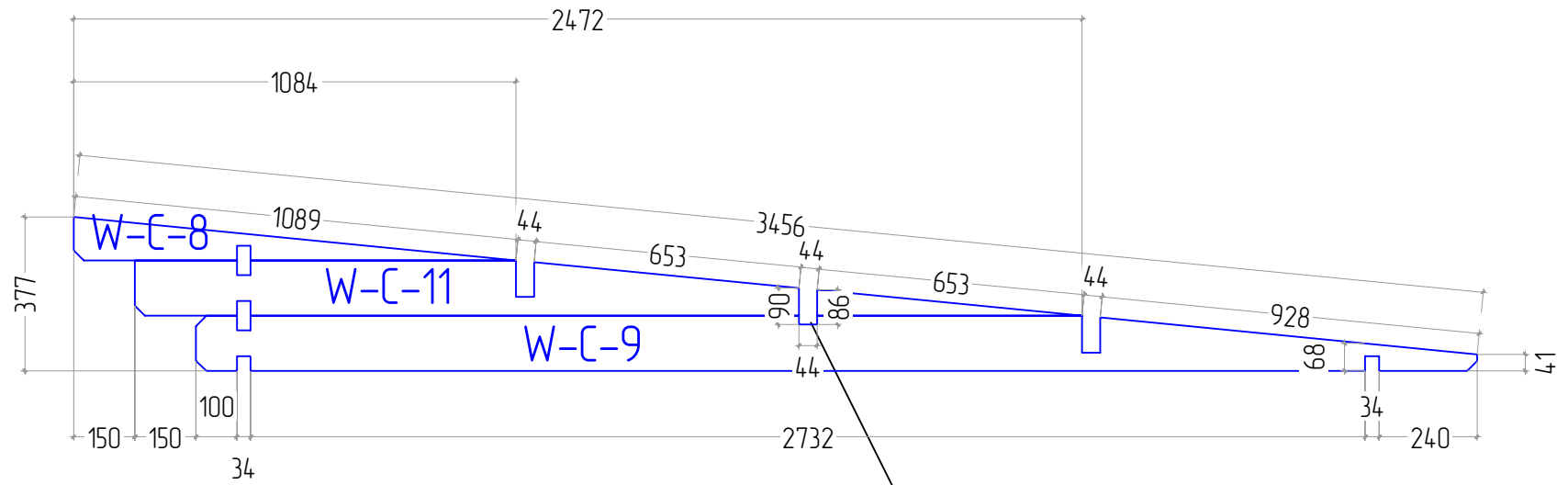

Размеры пазов
под дюкговые прогоны идентичны